

ANLMET 2005

60m winds

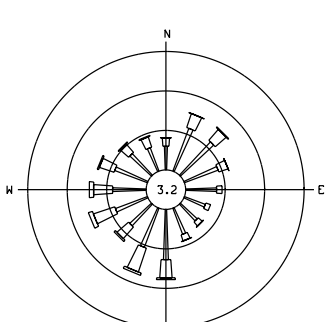
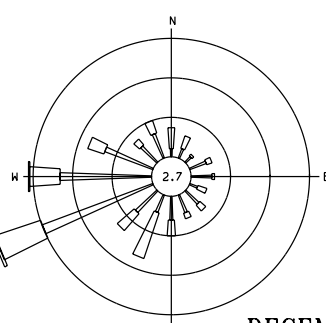
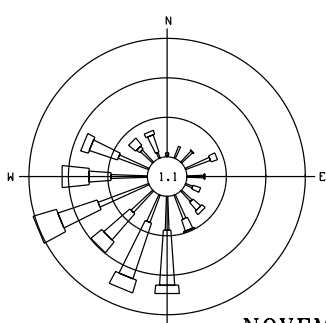
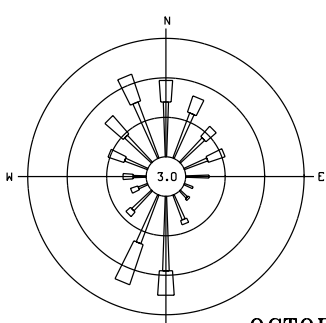
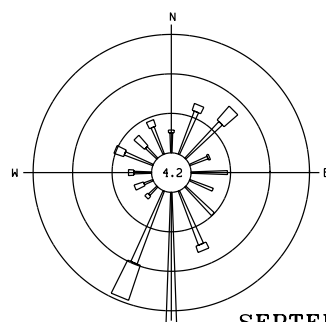
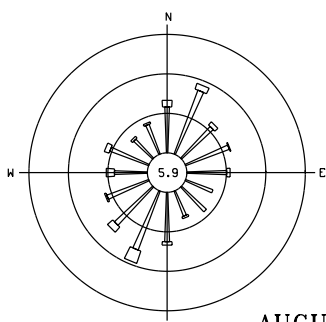
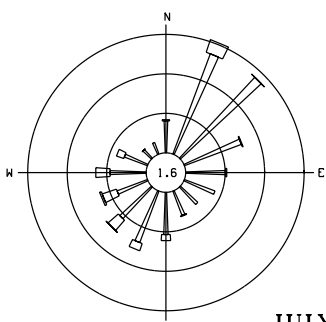
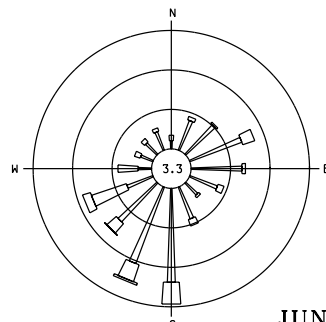
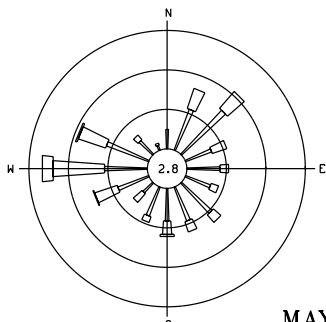
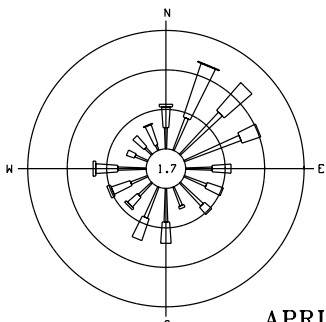
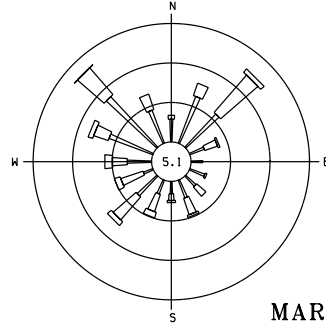
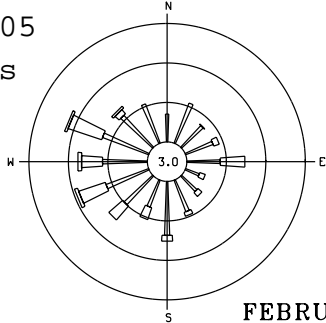
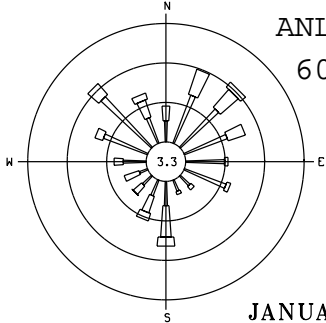

A = % of Calm (0-2 m/s)  
 B = 2.01-6 m/s  
 C = 6.01-10 m/s  
 D = >10.01 m/s

**SCALE**