

ANLMET 2004

60m winds

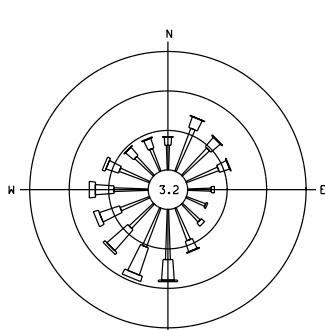

A = % of Calm (0-2 m/s)
 B = 2.01-6 m/s
 C = 6.01-10 m/s
 D = >10.01 m/s

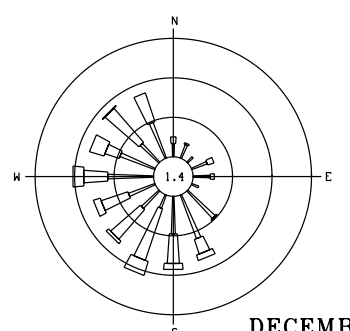
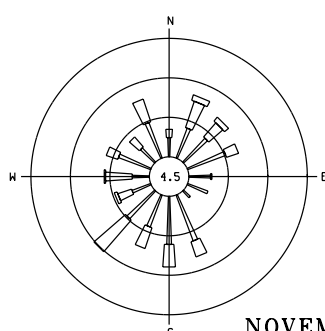
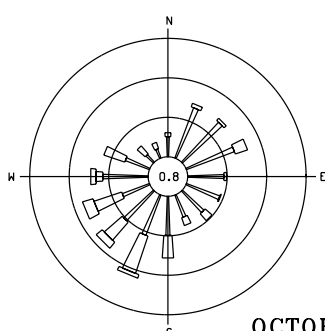
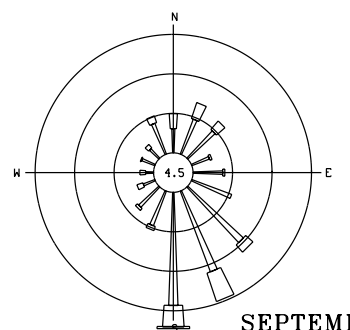
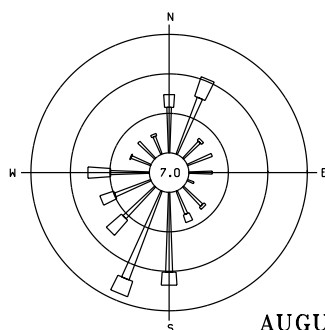
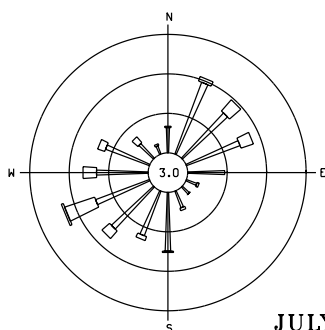
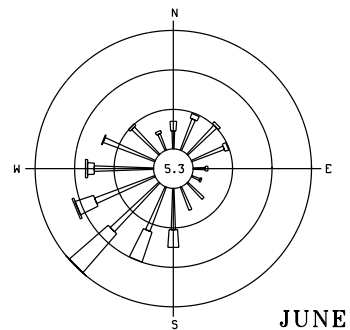
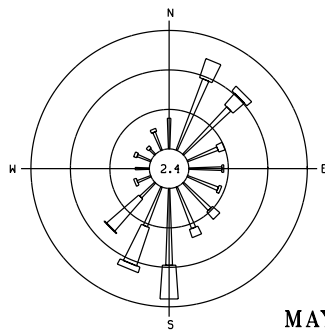
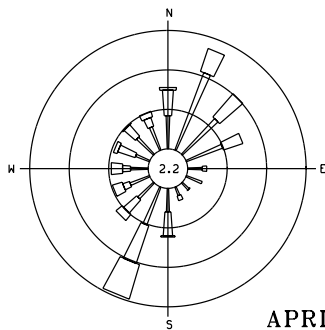
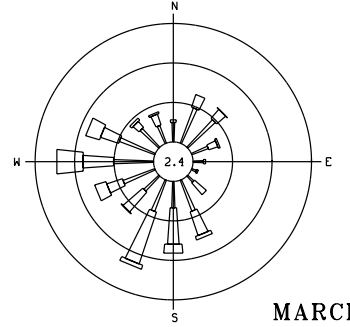
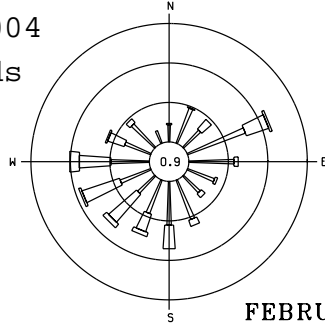
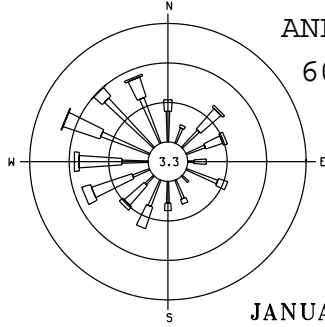