

ANLMET 2002

60m winds

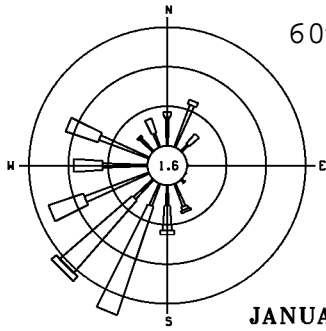

JANUARY

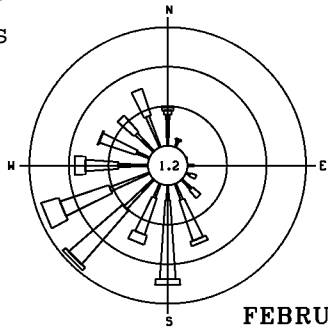

FEBRUARY

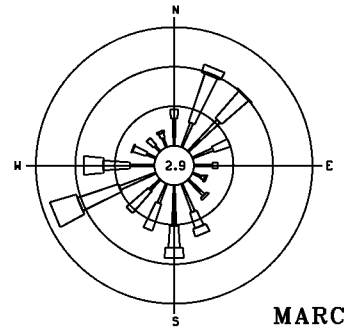

MARCH

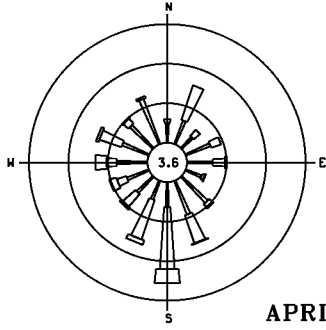

APRIL

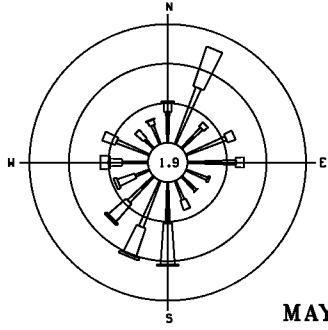

MAY

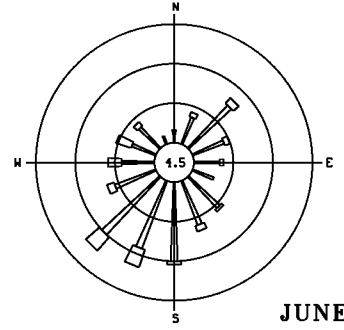

JUNE

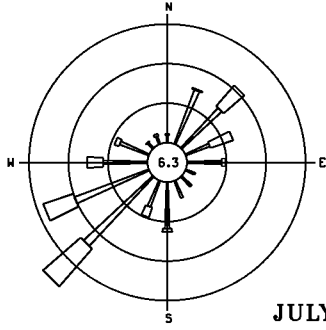

JULY

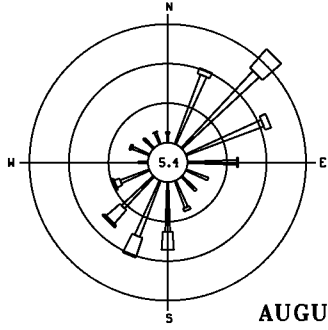

AUGUST

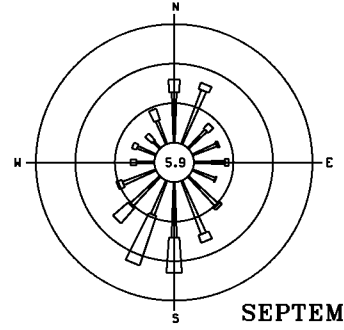

SEPTEMBER

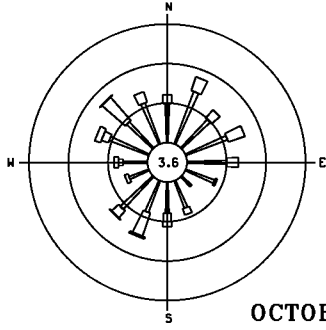

OCTOBER

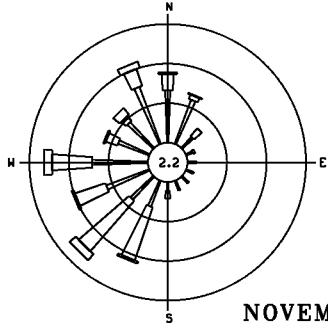

NOVEMBER

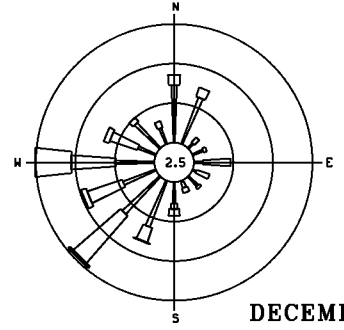

DECEMBER

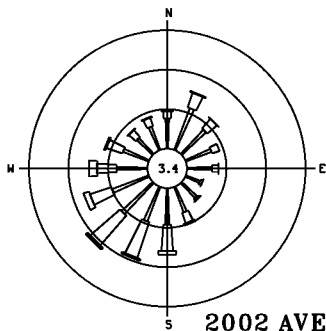

2002 AVERAGE

