

ANLMET 1992
winds 60m

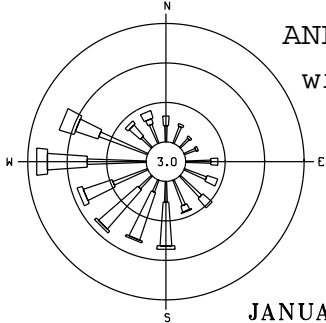

JANUARY

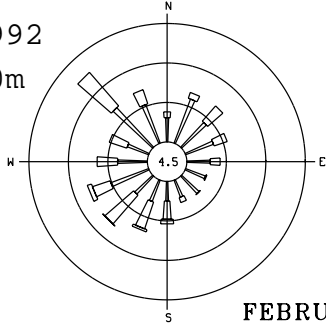

FEBRUARY

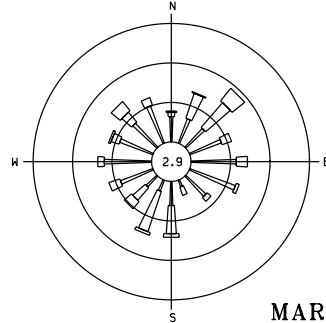

MARCH

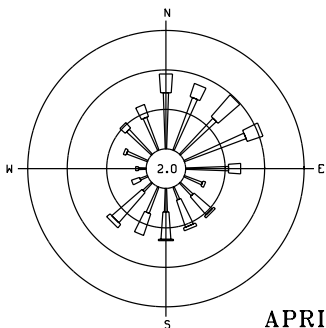

APRIL

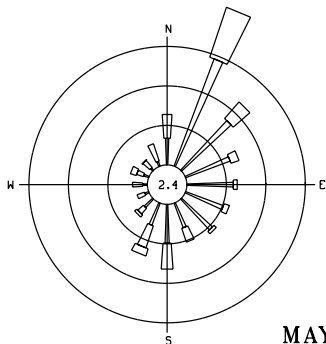

MAY

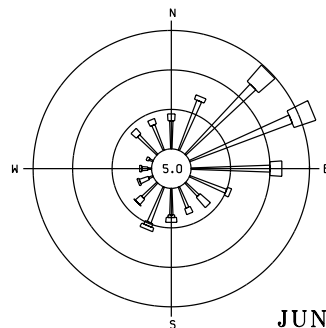

JUNE

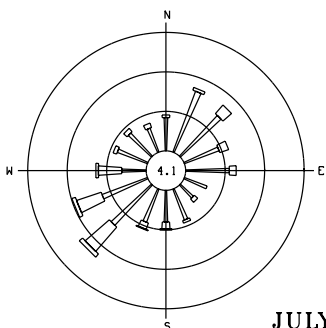

JULY

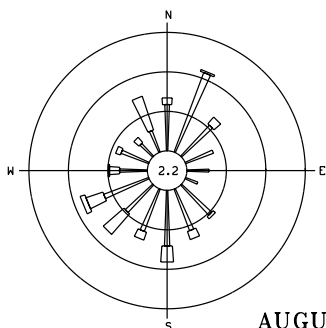

AUGUST

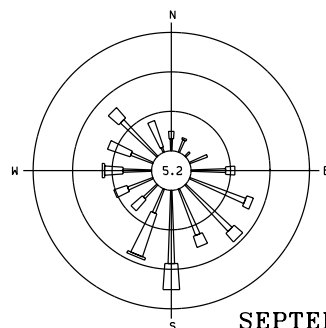

SEPTEMBER

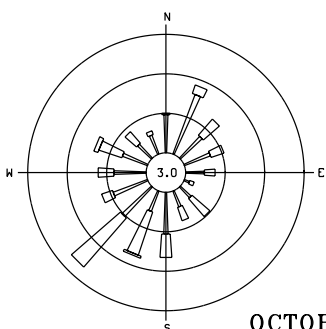

OCTOBER

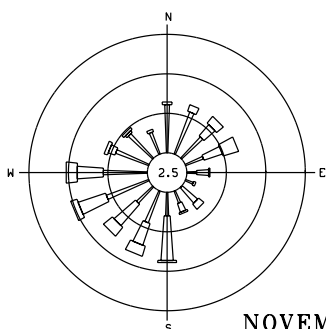

NOVEMBER

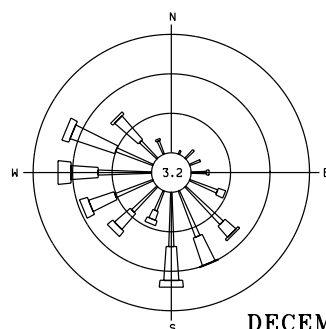

DECEMBER

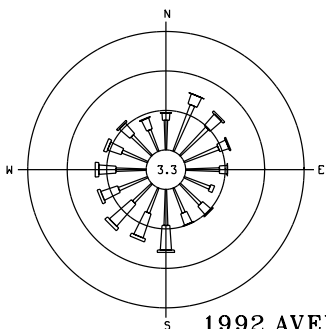

1992 AVERAGE

A = % of Calm (0-2 m/s)
B = 2.01-6 m/s
C = 6.01-10 m/s
D = >10.01 m/s

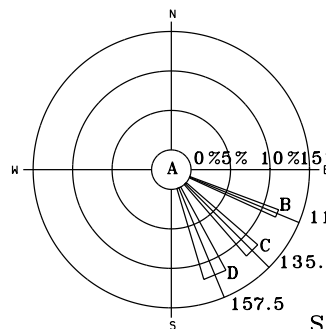

SCALE