

ANLMET 2001

60m winds

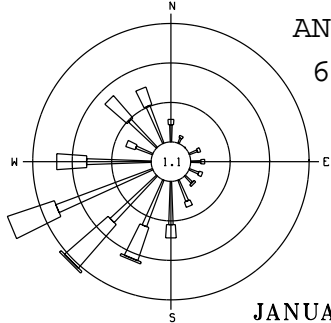

JANUARY

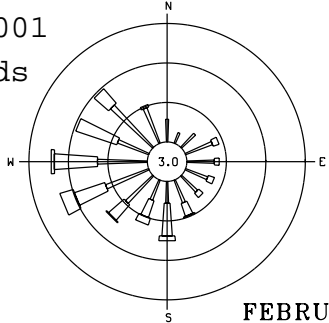

FEBRUARY

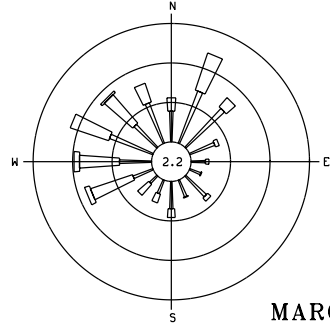

MARCH

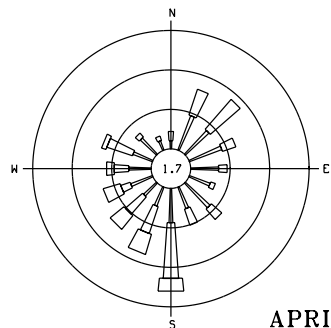

APRIL

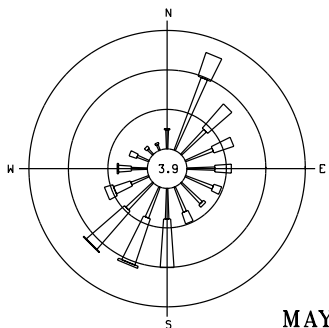

MAY

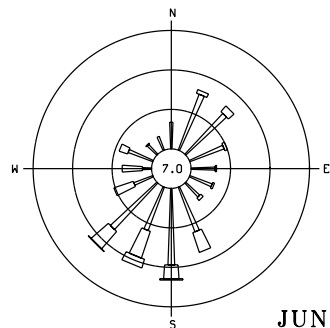

JUNE

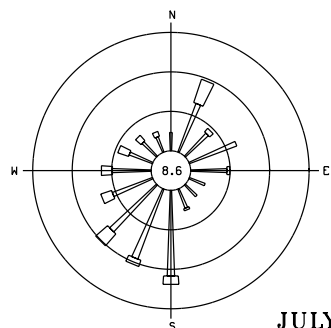

JULY

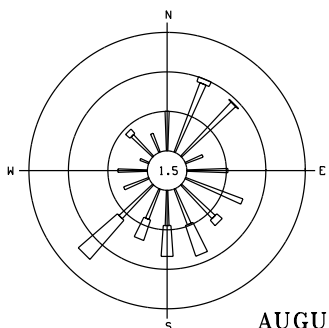

AUGUST

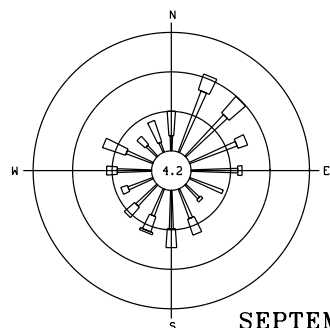

SEPTEMBER

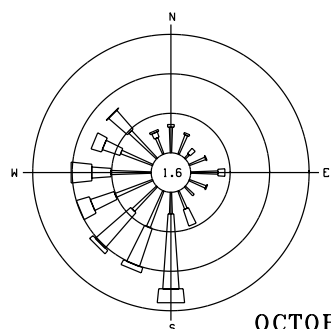

OCTOBER

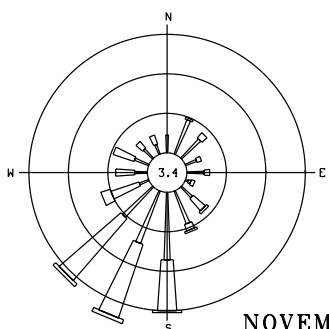

NOVEMBER

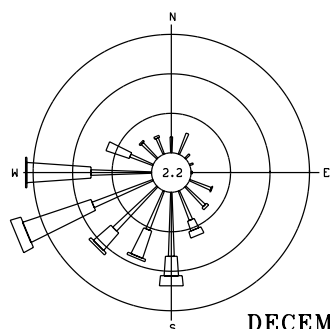

DECEMBER

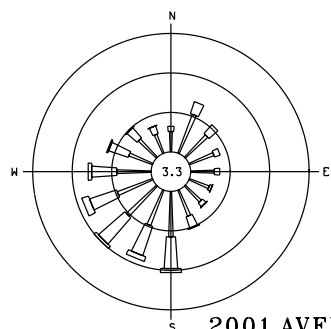

2001 AVERAGE

A = % of Calm (0-2 m/s)
 B = 2.01-6 m/s
 C = 6.01-10 m/s
 D = >10.01 m/s

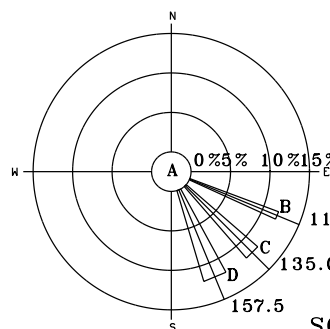

SCALE